



Technical features



Technical data

IP Rating	IP65
IK Rating	IK09
Material	High corrosion resistance die-cast copper-free aluminum body
Coating	Polyester powder coating with phosphochromating pre-finish
Screws	Stainless steel
Transformer	Electronic power supply 220/240V 50/60Hz built-in
Gasket	Silicone rubber
Glass	Tempered
Cable gland	Double nickel-plated brass cable gland PG11
Power cable	3 mt. neoprene power cable included

805001-805005

FLASH POLE MEDIUM

Round pole-mounted floodlight for outdoor installation on a pole diam. 60 mm or 76 mm. Phospho-chromatised and polyester powder coated die-cast copper-free aluminium body, tempered safety glass, moulded silicone gasket and stainless steel screws. Clamp for pole diam 60 mm or 76 mm included. Built-in LED driver 220-240V 50-60Hz, with 5 CREE XP-G3 high-power LED. IP65 rating.

805001

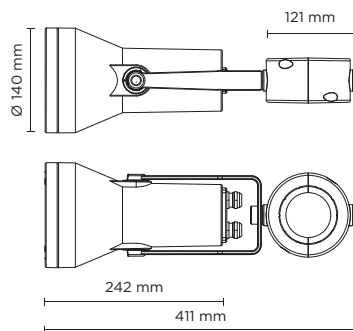

805005

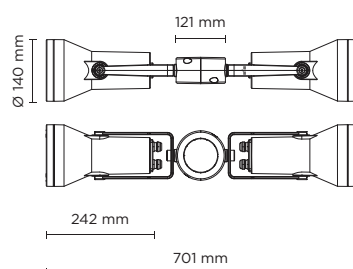





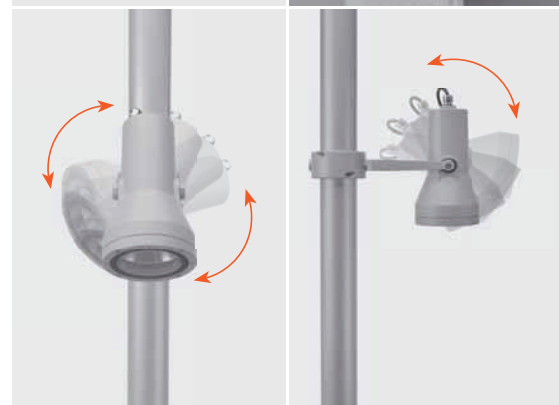

AC-026 Anti-glare visor for hydroflash medium



Graduated stainless steel insert



805001		SINGLE FLASH POLE MEDIUM - 8 WATT 220-240V 50-60HZ ELECTRONIC		
light source	light beam options	lumen output (lm)	lumin. efficacy (lm/w)	
3000°K warm-white				
high-power led	 10°	720	90.00	
high-power led	 30°	684	85.50	
high-power led	 45°	650	81.25	
4000°K neutral-white				
high-power led	 10°	750	93.75	
high-power led	 30°	713	89.13	
high-power led	 45°	677	84.63	







Colors options

-  Textured Grey
RAL 9006
-  Anthracite Grey
RAL 7016
-  Matt Black
(on request)

Technical data

Wattage	8 WATT
Light source	NR. 5 CREE "XP-G3" LED
Gross weight	3,00 Kg



805005		DOUBLE FLASH POLE MEDIUM - 2 X 8 WATT 220-240V 50-60HZ ELECTRONIC		
light source	light beam options	lumen output (lm)	lumin. efficacy (lm/w)	
3000°K warm-white				
high-power led	 10°	2 x 720	90.00	
high-power led	 30°	2 x 684	85.50	
high-power led	 45°	2 x 650	81.25	
4000°K neutral-white				
high-power led	 10°	2 x 750	93.75	
high-power led	 30°	2 x 713	89.13	
high-power led	 45°	2 x 677	84.63	

Colors options

-  Textured Grey
RAL 9006
-  Anthracite Grey
RAL 7016
-  Matt Black
(on request)

Technical data

Wattage	2 x 8 WATT
Light source	NR. 2 x 5 CREE "XP-G3" LED
Gross weight	5,60 Kg



POLES & ACCESSORIES

Full technical details of poles and accessories for poles are available at the end of the catalogue

BURIED POLES	
code	h. mm.
809901	3.500
809902	4.500
809903	5.500
809908	ACC.

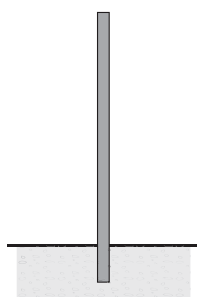

POLES WITH BASE-PLATE	
code	h. mm.
809904	3.000
809905	4.000
809906	5.000
809907	ACC.
809908	ACC.

